

PRODUCT INTRODUCTION

MP1570A1

SONET/SDH/PDH/ATM Analyzer

MEASUREMENT SOLUTIONS

ANRITSU CORPORATION

Copyright © 2001 by ANRITSU CORPORATION

The contents of this manual shall not be disclosed in any way or reproduced in any media without the express written permission of Anritsu Corporation.

MP1570A1 SONET/SDH/PDH/ATM Analyzer

Anritsu Corporation
Measurement Solutions
Marketing Dept. Digital.com Div.

Anritsu

Your Global Partner for the 21st Century

1570-1

External View of MP1570A1

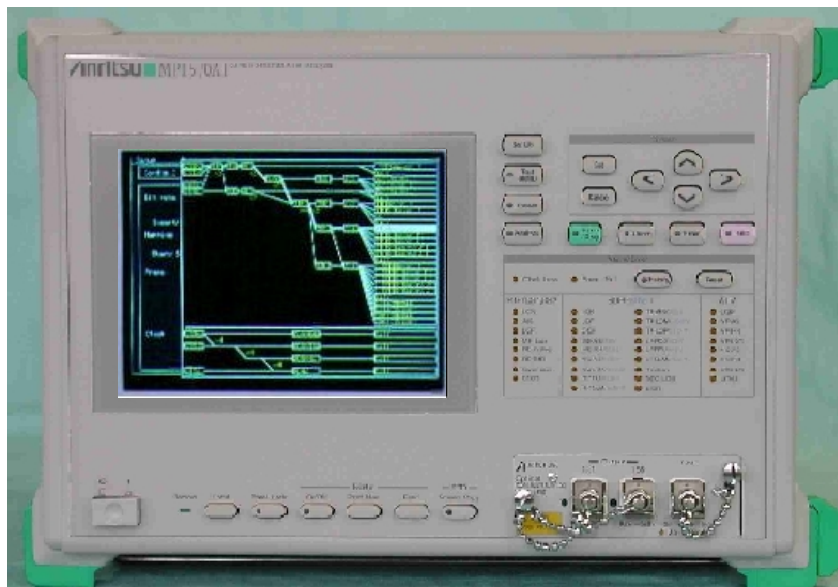

Anritsu

Your Global Partner for the 21st Century

1570-2

Features



- ◆ The MP1570A cannot perform measurements above 2.5G with the MP0121A unit for European (2,8,34,139M/SDH) system and MP0122A/B unit for North America (1.5,45M/SONET) system installed at the same time. To solve this problem, an extra slot was added in the MP1570A1.
- ◆ All the plug-in units for the MP1570A are supported and the software is also fully compatible.
- ◆ Only MP0122A/B inserted in the extra slot.
- ◆ It is impossible to measure US system (1.5,45M/SONET) and Europe system (2,8,34,139M/SDH) at the same time.
- ◆ In case of switching the MP0121A and MP0122A/B by panel operation, it takes as much time as setting up the power supply.
- ◆ Other functions are the same as the MP1570A.

Anritsu

Your Global Partner for the 21st Century

1570-3

Plug-In Unit Method



- Full Line of Interface Units
 - ◆ Optical 1.31, 1.55, 1.31/1.55
 - ◆ Electrical NRZ, CMI
- Optical Units with Built-in Power Meter

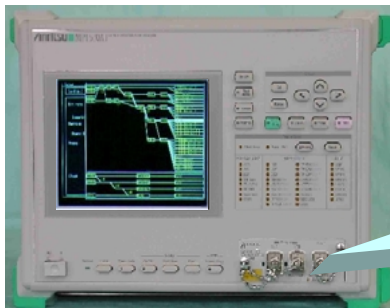

- ◆ Optical 156/622M (1.31) **MP0111A**
- ◆ Optical 156/622M (1.55) **MP0112A**
- ◆ Optical 156/622M (1.31/1.55) **MP0113A**
- ◆ CMI **MP0105A**
- ◆ NRZ (156M/622M) **MP0108A**

Anritsu

Your Global Partner for the 21st Century

1570-4

Plug-in Unit Method

– Supports Variety of Measurements using Plug-in Units



MP1570A1

Interface Units

- 2.5/10G MU150000A
- Optical 10G Tx (1.55) MU150001A/B
- Optical 10G Tx (1.55) High power MU150031A/C
- Optical 10G Tx (1.31) MU150061A/B
- Optical 10G Rx (Narrow) MU150002A
- Optical 10G Rx (Wide) MU150017A/B
- 2.5G MU150008A/150009A/150010A
- 2/8/34/139/156M MP0121A
- 1.5/45/52M MP0122A/B
- ATM MP0123A
- Jitter/Wander MU150005A
 - 2/8/34/139M, 156/622M
 - 1.5/45M, 52/156/622M
 - 2/8/34/139M, 1.5/45M, 52/156/622M
- 2.5G Jitter MU150006A
- Add/Drop MU150007A
- MU150011A
- MP0131A

Plug-in Structure

Right Side Cover of MP1570A



For MP0122A/B

- ← Slot 1
- ← Slot 2
- ← Slot 3
- ← Slot 4
- ← Slot 5



Plug-in Structure

◆ 10G

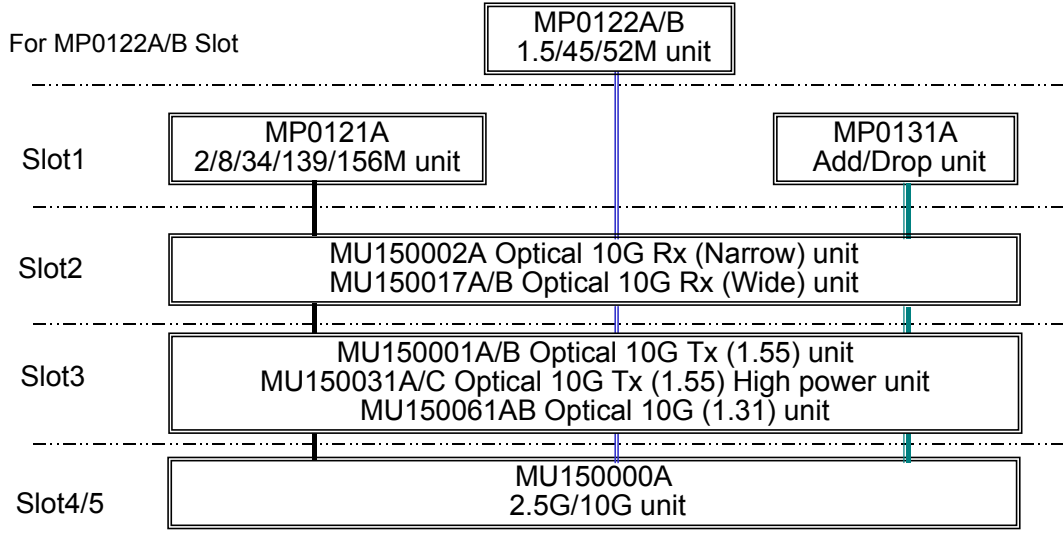

Your Global Partner for the 21st Century

1570-7



Plug-in Structure

◆ 2.5G

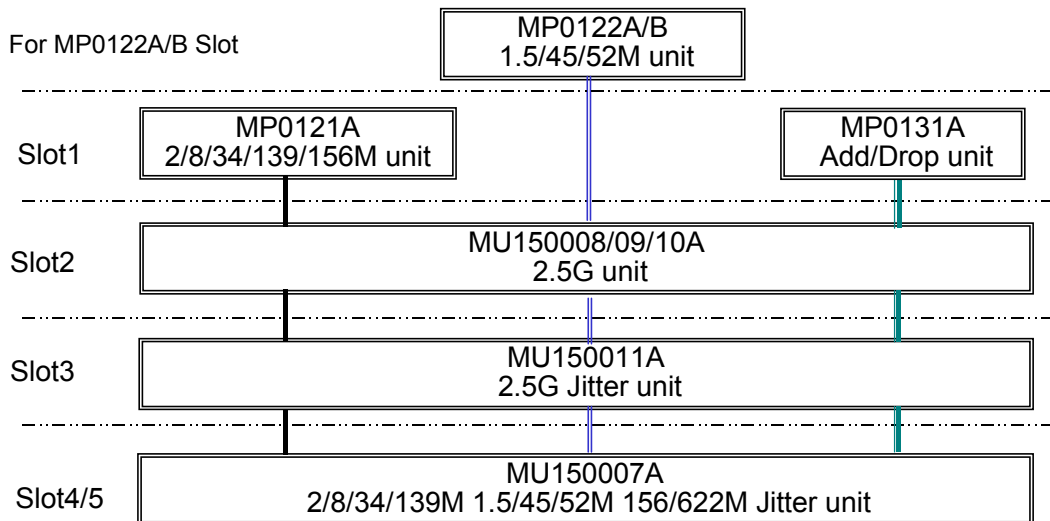

Your Global Partner for the 21st Century

1570-8

Plug-in Structure

◆ 622M

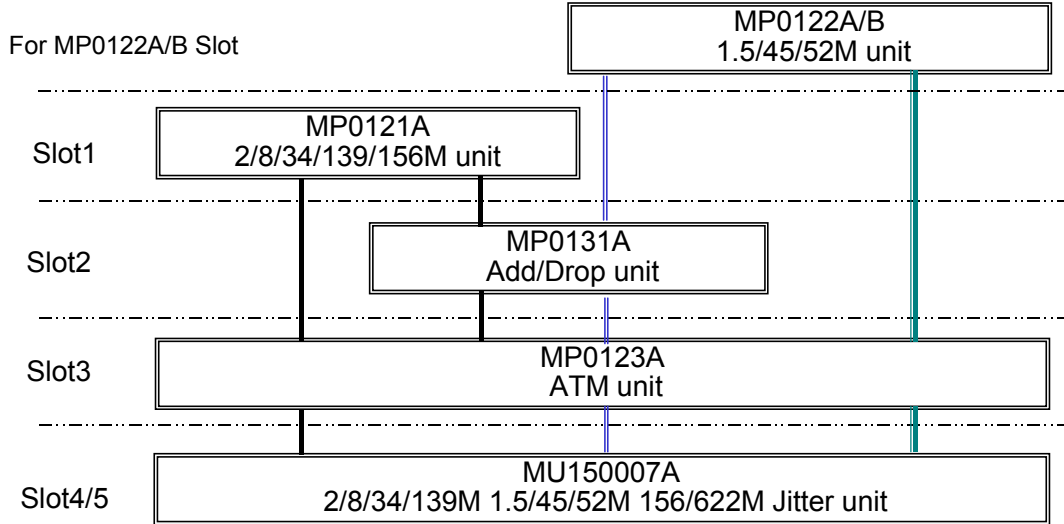

All SDH/SONET Mappings Supported

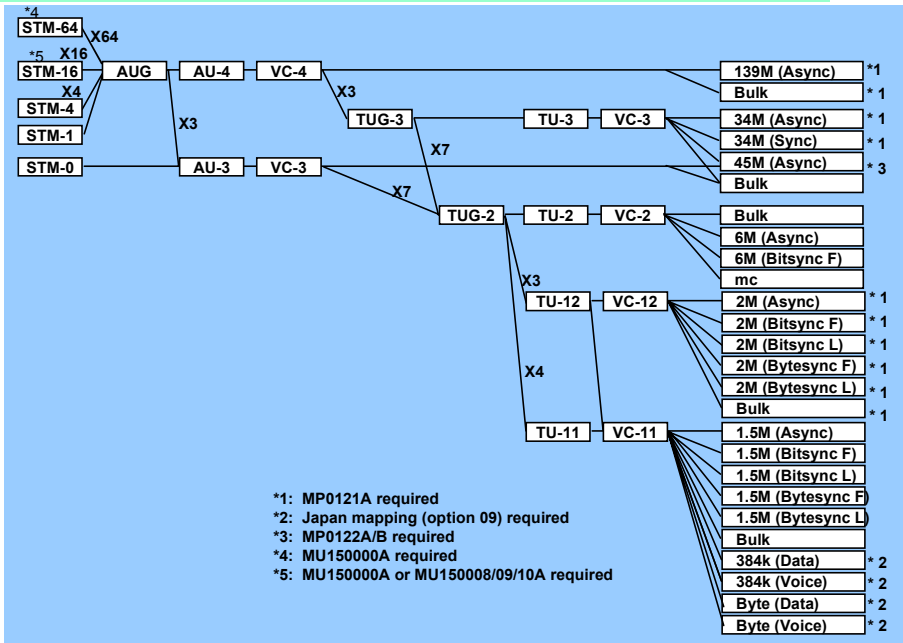



All SDH/SONET Mappings Supported

◆ Add/Drop (With MP0131A)

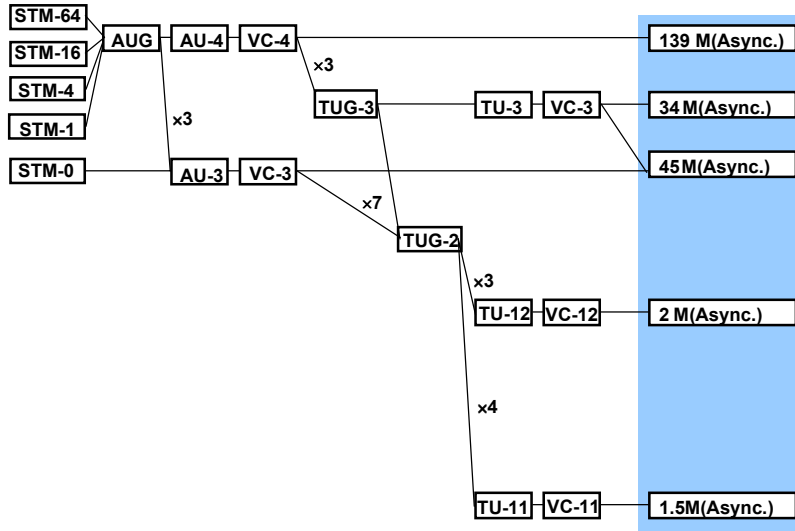

Add/Drop Interface



Your Global Partner for the 21st Century

1570-11



Concatenation Mapping

◆ STM-1c to STM-64c Concatenation Mapping

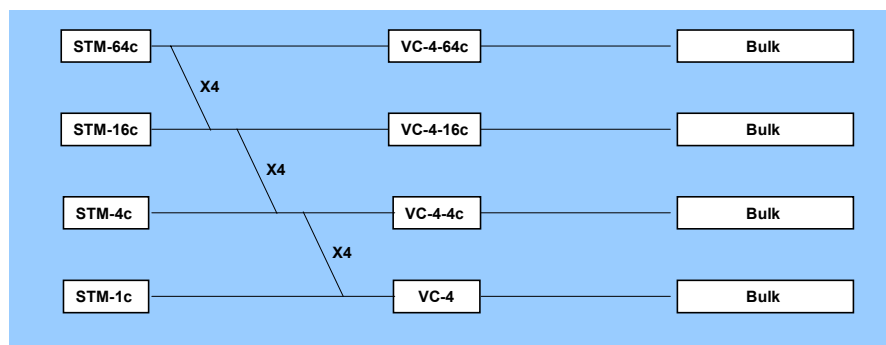

Your Global Partner for the 21st Century

1570-12

Anritsu

Specifications are subject to change without notice.

ANRITSU CORPORATION MEASUREMENT SOLUTIONS

5-10-27, Minamiazabu, Minato-ku, Tokyo 106-8570, Japan
Phone: +81-3-3446-1111
Telex: J34372
Fax: +81-3-3442-0235

● U.S.A. ANRITSU COMPANY

North American Region Headquarters
1155 East Collins Blvd., Richardson, Tx 75081, U.S.A.
Toll Free: 1-800-ANRITSU (267-4878)
Phone: +1-972-644-1777
Fax: +1-972-671-1877

● Canada ANRITSU ELECTRONICS LTD.

Unit 102, 215 Stafford Road West
Nepean, Ontario K2H 9C1, Canada
Phone: +1-613-828-4090
Fax: +1-613-828-5400

● Brasil ANRITSU ELETRÔNICA LTDA.

Praia de Botafogo 440, Sala 2401 CEP 22250-040,
Rio de Janeiro, RJ, Brasil
Phone: +55-21-5276922
Fax: +55-21-537-1456

● U.K. ANRITSU LTD.

200 Capability Green, Luton, Bedfordshire LU1 3LU, U.K.
Phone: +44-1582-433200
Fax: +44-1582-731303

● Germany ANRITSU GmbH

Grafenberger Allee 54-56, 40237 Düsseldorf, Germany
Phone: +49-211-96855-0
Fax: +49-211-96855-55

● France ANRITSU S.A.

9, Avenue du Québec Z.A. de Courtabœuf 91951 Les
Ulis Cedex, France
Phone: +33-1-60-92-15-50
Fax: +33-1-64-46-10-65

● Italy ANRITSU S.p.A.

Via Elio Vittorini, 129, 00144 Roma EUR, Italy
Phone: +39-06-509-9711
Fax: +39-06-502-24-25

● Sweden ANRITSU AB

Botvid Center, Fittja Backe 1-3 145 84 Stockholm,
Sweden
Phone: +46-853470700
Fax: +46-853470730

● Spain ANRITSU ELECTRÓNICA, S.A.

Europa Empresarial Edificio Londres, Planta 1, Oficina
6 C/ Playa de Liencres, 2 28230 Las Rozas. Madrid,
Spain
Phone: +34-91-6404460
Fax: +34-91-6404461

● Singapore ANRITSU PTE LTD.

10, Hoe Chiang Road #07-01/02, Keppel Towers,
Singapore 089315
Phone: +65-282-2400
Fax: +65-282-2533

● Hong Kong ANRITSU COMPANY LTD.

Suite 719, 7/F., Chinachem Golden Plaza, 77 Mody
Road, Tsimshatsui East, Kowloon, Hong Kong, China
Phone: +852-2301-4980
Fax: +852-2301-3545

● Korea ANRITSU CORPORATION

14F Hyun Juk Bldg. 832-41, Yeoksam-dong,
Kangnam-ku, Seoul, Korea
Phone: +82-2-553-6603
Fax: +82-2-553-6604-5

● Australia ANRITSU PTY LTD.

Unit 3/170 Forster Road Mt. Waverley, Victoria, 3149,
Australia
Phone: +61-3-9558-8177
Fax: +61-3-9558-8255

● Taiwan ANRITSU COMPANY INC.

6F, 96, Sec. 3, Chien Kou North Rd. Taipei, Taiwan
Phone: +886-2-2515-6050
Fax: +886-2-2509-5519